

## CHIP COIL (CHIP INDUCTOR) for Consumer equipment & Industrial equipment LQH66SN□□□□03L REFERENCE SPECIFICATION

### 1. Scope

This reference specification applies to Chip coil (Chip Inductor) LQH66SN\_03L series.

#### 1.1 Specific applications:

- Power equipment: Products that can be used in power equipment such as renewable energy equipment, energy storage equipment and EV charging equipment and whose functions are not directly related to the protection of human life and property.
- Industrial equipment: Products that can be used in industrial equipment such as base stations, manufacturing equipment, industrial robotics equipment, and measurement equipment, and whose functions do not directly relate to the protection of human life and property.
- Medical equipment (GHTF Class C) \*Except for implant/surgery/auto injector: Products that can be used for medical equipment of Class C of the international classification class GHTF and whose malfunction is considered to pose a relatively high risk to the human body.
- Medical equipment (GHTF Class A and B): Products that can be used for medical equipment regulated by Class A and Class B of the international classification class GHTF and whose functions do not directly relate to the protection of human life and property.
- Consumer equipment: Products that can be used in consumer equipment such as home appliances, audio/visual equipment, communication equipment, information equipment, office equipment, and household robotics, and whose functions are not directly related to the protection of human life and property.

#### 1.2 Unsuitable application:

Applications listed in "Limitation of applications" in this reference specification.

WE DISCLAIM ANY LOSS AND DAMAGES ARISING FROM OR IN CONNECTION WITH THE PRODUCTS INCLUDING BUT NOT LIMITED TO THE CASE SUCH LOSS AND DAMAGES CAUSED BY THE UNEXPECTED ACCIDENT, IN EVENT THAT THE PRODUCT IS APPLIED FOR THE PURPOSE WHICH IS SPECIFIED ABOVE AS THE UNSUITABLE APPLICATION FOR THE PRODUCT.

### 2.Part Numbering

(ex) 

LQ	H	66	S	N	R27	M	0	3	L
Product ID	Structure	Dimension (L×W)	Applications and Characteristics	Category	Inductance	Tolerance	Features	Electrode	Packaging L: Taping

### 3.Rating

- Operating Temperature Range. -40 to +80°C
- Storage Temperature Range. -40 to +85°C

Customer Part Number	MURATA Part Number	Inductance		DC Resistance (Ω)	Self Resonant Frequency (MHz min)	* Rated Current (A)
		(μH)	Tolerance (%)			
	LQH66SNR27M03L	0.27	±20	0.007 ± 40%	300	6.0
	LQH66SNR68M03L	0.68		0.010 ± 40%	180	5.3
	LQH66SN1R0M03L	1.0		0.013 ± 40%	150	4.7
	LQH66SN1R5M03L	1.5		0.016 ± 40%	110	3.8
	LQH66SN2R2M03L	2.2		0.019 ± 40%	80	3.3
	LQH66SN3R3M03L	3.3		0.022 ± 40%	40	2.6
	LQH66SN4R7M03L	4.7		0.025 ± 40%	30	2.2
	LQH66SN6R8M03L	6.8		0.029 ± 40%	25	1.8
	LQH66SN100M03L	10		0.036 ± 40%	20	1.6
	LQH66SN150M03L	15		0.069 ± 40%	17	1.3
	LQH66SN220M03L	22		0.087 ± 40%	15	1.1
	LQH66SN330M03L	33		0.14 ± 40%	12	0.86
	LQH66SN470M03L	47		0.17 ± 40%	10	0.76
	LQH66SN680M03L	68		0.29 ± 40%	7.6	0.60
	LQH66SN101M03L	100		0.36 ± 40%	6.5	0.52
	LQH66SN151M03L	150		0.63 ± 40%	5.0	0.42
	LQH66SN221M03L	220	0.79 ± 40%	4.0	0.35	

Customer Part Number	MURATA Part Number	Inductance		DC Resistance (Ω)	Self Resonant Frequency (MHz min)	* Rated Current (A)
		(μH)	Tolerance (%)			
	LQH66SN331M03L	330	±20	1.8 ± 40%	3.2	0.28
	LQH66SN471M03L	470		2.2 ± 40%	2.5	0.24
	LQH66SN681M03L	680		3.9 ± 40%	2.0	0.20
	LQH66SN102M03L	1000		4.9 ± 40%	1.7	0.16
	LQH66SN222M03L	2200		9.4 ± 40%	1.2	0.10
	LQH66SN472M03L	4700		19.5 ± 40%	0.8	0.07
	LQH66SN103M03L	10000		39.7 ± 40%	0.5	0.05

\* When applied Rated current to the Products, Inductance will be within ±10% of initial Inductance value.  
 When applied Rated current to the Products ,temperature rise caused by self-generated heat shall be limited to 40°C max.

### 4. Testing Conditions

《Unless otherwise specified》

Temperature : Ordinary Temperature (15 to 35°C)  
 Humidity : Ordinary Humidity (25 to 85 %(RH))

《In case of doubt》

Temperature : 20 ± 2°C  
 Humidity : 60 to 70 %(RH)  
 Atmospheric Pressure : 86 to 106 kPa

### 5.Appearance and Dimensions

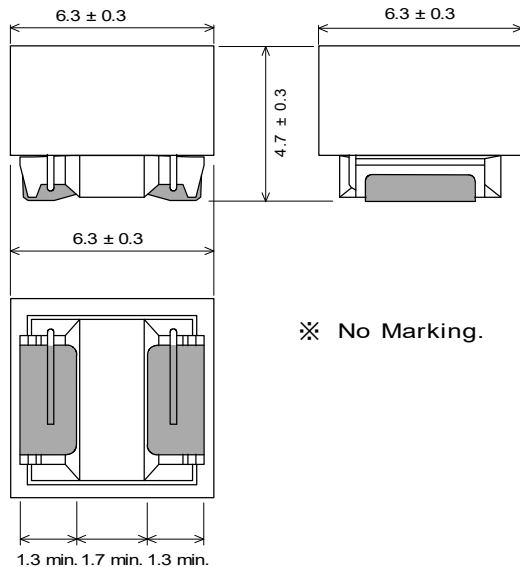

■ Unit Mass (Typical value)  
 0.71g

( in mm )

※ No Marking.

### 6.Electrical Performance

No.	Item	Specification	Test Method
6.1	Inductance	Inductance shall meet item 3.	Measuring Equipment : KEYSIGHT 4194A or equivalent Measuring Frequency : 1 MHz / 0.12 to 68 μH 100 kHz / 100 to 680 μH 10 kHz / 1000 to 10000 μH
6.2	DC Resistance	DC Resistance shall meet item 3.	Measuring Equipment : Digital multi meter
6.3	Self Resonant Frequency(S.R.F)	S.R.F shall meet item 3.	Measuring Equipment : f < 1 MHz : KEYSIGHT 4194A or equivalent f ≥ 1 MHz : KEYSIGHT E4991A or equivalent

## 7.Mechanical Performance

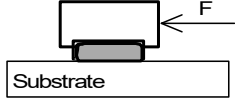
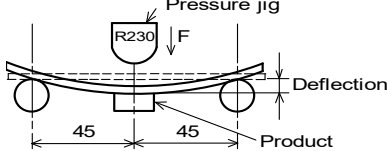
No.	Item	Specification	Test Method
7.1	Shear Test	Chip coil shall not be damaged.	Substrate : Glass-epoxy substrate Applied Direction : Chip Coil  Force : 10N Hold Duration : 5±1 s
7.2	Bending Test		Substrate : Glass-epoxy substrate (100 × 40 × 1.6mm) Speed of Applying Force : 1mm / s Deflection : 2mm Hold Duration : 30 s  (in mm)
7.3	Vibration	Chip coil shall not be damaged.	Oscillation Frequency : 10 to 55 to 10Hz for 1 minute Total Amplitude : 1.5mm Testing Time : A period of 2 hours in each of 3 mutually perpendicular directions. (Total 6 hours)
7.4	Solderability	The wetting area of the electrode shall be at least 90% covered with new solder coating.	Flux : Ethanol solution of rosin, 25(wt)% (Immersed for 5s to 10s) Solder : Sn-3.0Ag-0.5Cu Pre-Heating : 150±10°C / 60 to 90seconds Solder Temperature : 240±5°C Immersion Time : 3±1 s
7.5	Resistance to Soldering Heat	Appearance : No damage Inductance Change : within ±5%	Flux : Ethanol solution of rosin, 25(wt)% (Immersed for 5s to 10s) Solder : Sn-3.0Ag-0.5Cu Pre-Heating : 150±10°C / 60 to 90seconds Solder Temperature : 270±5°C Immersion Time : 10±1 s Then measured after exposure in the room condition for 24±2 hours.

**8.Environmental Performance (It shall be soldered on the substrate.)**

No.	Item	Specification	Test Method
8.1	Heat Resistance	Appearance : No damage Inductance Change : within $\pm 5\%$ DC Resistance Change : within $\pm 5\%$	Temperature : $85\pm 2^\circ\text{C}$ Time : 1000h (+48h , -0h) Then measured after exposure in the room condition for $24\pm 2$ hours.
8.2	Cold Resistance		Temperature : $-40\pm 2^\circ\text{C}$ Time : 1000h (+48h , -0h) Then measured after exposure in the room condition for $24\pm 2$ hours.
8.3	Humidity		Temperature : $40\pm 2^\circ\text{C}$ Humidity : 90 to 95%(RH) Time : 1000h (+48h , -0h) Then measured after exposure in the room condition for $24\pm 2$ hours.
8.4	Temperature Cycle		1 cycle : 1 step : $-40\pm 2^\circ\text{C}$ / $30\pm 3$ minutes 2 step : Ordinary temp. / 10 to 15 minutes 3 step : $+85\pm 2^\circ\text{C}$ / $30\pm 3$ min 4 step : Ordinary temp. / 10 to 15 minutes Total of 10 cycles Then measured after exposure in the room condition for $24\pm 2$ hours.

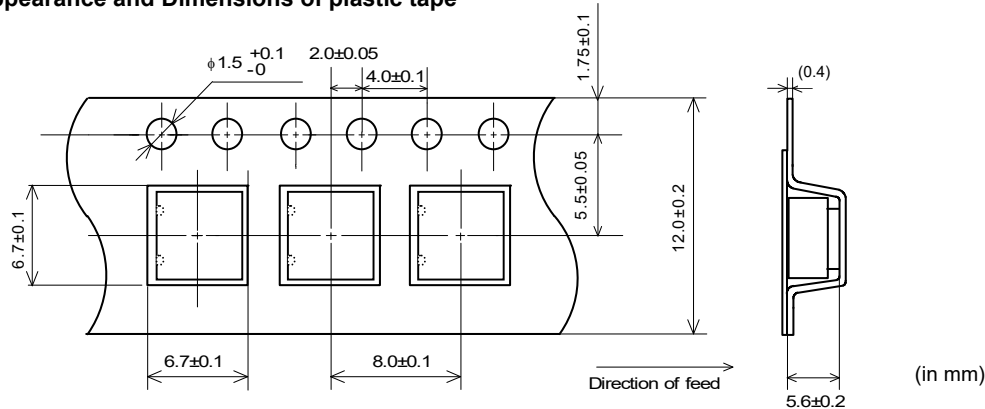
**9. Specification of Packaging****9.1 Appearance and Dimensions of plastic tape****9.2 Specification of Taping**

- (1) Packing quantity (standard quantity)  
350 pcs / reel
- (2) Packing Method  
Products shall be packed in the each embossed cavity of plastic tape and sealed by cover tape.
- (3) Sprocket hole  
The sprocket holes are to the right as the tape is pulled toward the user.
- (4) Spliced point  
Plastic tape and Cover tape has no spliced point.
- (5) Missing components number  
Missing components number within 0.025 % of the number per reel or 1 pc., whichever is greater, and are not continuous. The specified quantity per reel is kept.

**9.3 Pull Strength**

Embossed carrier tape	10N min.
Cover tape	5N min.



**10. ⚠ Caution****10.1 Limitation of Applications**

The products listed in the reference specification (hereinafter the product(s) is called as the "Product(s)") are designed and manufactured for applications specified in the reference specification (hereinafter called as the "Specific Application").

We shall not warrant anything in connection with the Products including fitness, performance, adequateness, safety, or quality, in the case of applications listed in from (1) to (11) written at the end of this precautions, which may generally require high performance, function, quality, management of production or safety. Therefore, the Product shall be applied in compliance with the specific application.

WE DISCLAIM ANY LOSS AND DAMAGES ARISING FROM OR IN CONNECTION WITH THE PRODUCTS INCLUDING BUT NOT LIMITED TO THE CASE SUCH LOSS AND DAMAGES CAUSED BY THE UNEXPECTED ACCIDENT, IN EVENT THAT (i) THE PRODUCT IS APPLIED FOR THE PURPOSE WHICH IS NOT SPECIFIED AS THE SPECIFIC APPLICATION FOR THE PRODUCT, AND/OR (ii) THE PRODUCT IS APPLIED FOR ANY FOLLOWING APPLICATION PURPOSES FROM (1) TO (11) (EXCEPT THAT SUCH APPLICATION PURPOSE IS UNAMBIGUOUSLY SPECIFIED AS SPECIFIC APPLICATION FOR THE PRODUCT IN OUR CATALOG SPECIFICATION FORMS, DATASHEETS, OR OTHER DOCUMENTS OFFICIALLY ISSUED BY US\*).

- (1) Aircraft equipment
- (2) Aerospace equipment
- (3) Undersea equipment
- (4) Power plant control equipment
- (5) Medical equipment
- (6) Transportation equipment
- (7) Traffic control equipment
- (8) Disaster prevention/security equipment
- (9) Industrial data-processing equipment
- (10) Combustion/explosion control equipment
- (11) Equipment with complexity and/or required reliability equivalent to the applications listed in the above.

For exploring information of the Products which will be compatible with the particular purpose other than those specified in the reference specification, please contact our sales offices, distribution agents, or trading companies with which you make a deal, or via our web contact form.

Contact form: <https://www.murata.com/contactform>

\* We may design and manufacture particular Products for applications listed in (1) to (11). Provided that, in such case we shall unambiguously specify such Specific Application in the reference specification without any exception.

Therefore, any other documents and/or performances, whether exist or non-exist, shall not be deemed as the evidence to imply that we accept the applications listed in (1) to (11).

**10.2 Corrosive gas**

Please refrain from use since contact with environments with corrosive gases (sulfur gas [hydrogen sulfide, sulfur dioxide, etc.], chlorine, ammonia, etc.) or oils (cutting oil, silicone oil, etc.) that have come into contact with the previously stated corrosive gas environment will result in deterioration of product quality or an open from deterioration due to corrosion of product electrode, etc. We will not bear any responsibility for use under these environments.

**11. Notice**

This product is designed for solder mounting.

Please consult us in advance for applying other mounting method such as conductive adhesive.

**11.1 Land pattern designing (Reflow Soldering)**

Recommended land pattern for reflow soldering is as follows:

It has been designed for Electric characteristics and solderability.

Please follow the recommended patterns. Otherwise, their performance which includes electrical performance or solderability may be affected, or result to "position shift" in soldering process.

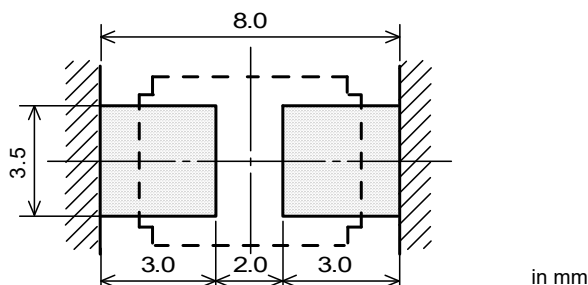

**11.2 Flux, Solder**

Flux	<ul style="list-style-type: none"> <li>• Use rosin-based flux.</li> <li>• Don't use highly acidic flux with halide content exceeding 0.2(wt)% (chlorine conversion value).</li> <li>• Don't use water-soluble flux.</li> </ul>
Solder	<ul style="list-style-type: none"> <li>• Use Sn-3.0Ag-0.5Cu solder</li> <li>• Standard thickness of solder paste : 200 μm to 300 μm</li> </ul>

Other flux (except above) Please contact us for details, then use.

**11.3 soldering conditions (Reflow)**

- Pre-heating should be in such a way that the temperature difference between solder and product surface is limited to 150°C max. Cooling into solvent after soldering also should be in such a way that the temperature difference is limited to 100°C max.
- Insufficient pre-heating may cause cracks on the product, resulting in the deterioration of product quality.
- Standard soldering profile and the limit soldering profile is as follows.
- The excessive limit soldering conditions may cause leaching of the electrode and / or resulting in the deterioration of product quality.

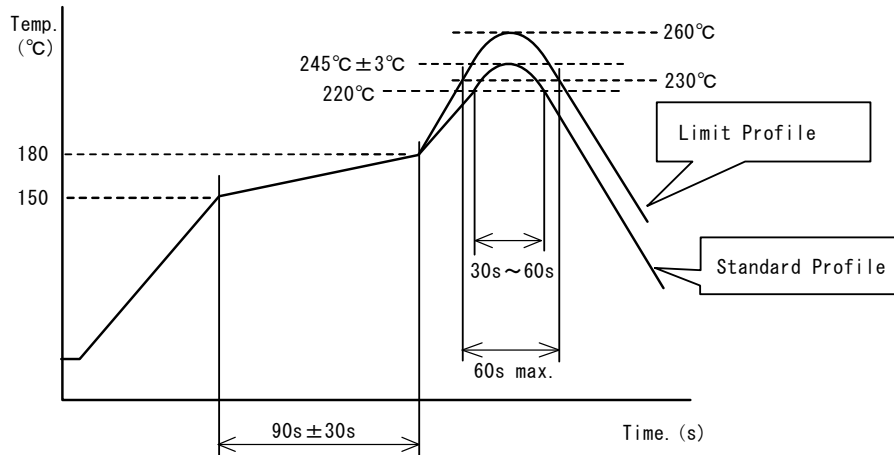

	Standard Profile	Limit Profile
Pre-heating	150~180°C、90s±30s	
Heating	above 220°C、30s~60s	above 230°C、60s max.
Peak temperature	245±3°C	260°C, 10s
Cycle of reflow	2 times	1 time

**11.4 Reworking with soldering iron.**

The following conditions must be strictly followed when using a soldering iron.

Pre-heating	150°C, 1 min
Tip temperature	350°C max.
Soldering iron output	80W max.
Tip diameter	φ3mm max.
Soldering time	3(+1,-0)s
Times	2 times

Note : Do not directly touch the products with the tip of the soldering iron in order to prevent the crack on the products due to the thermal shock.

**11.5 Solder Volume**

- Solder shall be used not to be exceeded the upper limits as shown below.
- Accordingly increasing the solder volume, the mechanical stress to Chip is also increased. Exceeding solder volume may cause the failure of mechanical or electrical performance.

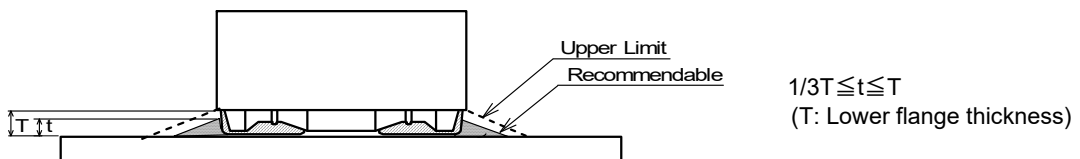

### 11.6 Product's location

The following shall be considered when designing and laying out P.C.B.'s.

- (1) P.C.B. shall be designed so that products are not subject to the mechanical stress due to warping the board.

[Products direction]

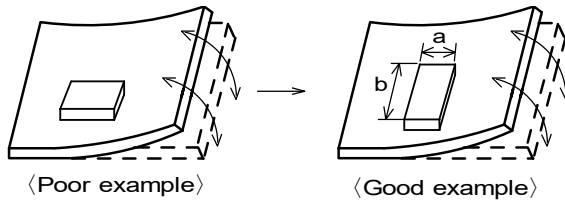

Products shall be located in the sideways direction (Length:  $a < b$ ) to the mechanical stress.

- (2) Components location on P.C.B. separation.

It is effective to implement the following measures, to reduce stress in separating the board.

It is best to implement all of the following three measures; however, implement as many measures as possible to reduce stress.

Contents of Measures	Stress Level
(1) Turn the mounting direction of the component parallel to the board separation surface.	$A > D *1$
(2) Add slits in the board separation part.	$A > B$
(3) Keep the mounting position of the component away from the board separation surface.	$A > C$

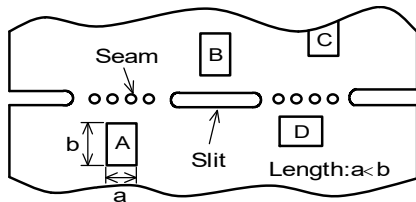

\*1  $A > D$  is valid when stress is added vertically to the perforation as with Hand Separation.  
If a Cutting Disc is used, stress will be diagonal to the PCB, therefore  $A > D$  is invalid.

- (3) Mounting Components Near Screw Holes

When a component is mounted near a screw hole, it may be affected by the board deflection that occurs during the tightening of the screw. Mount the component in a position as far away from the screw holes as possible.

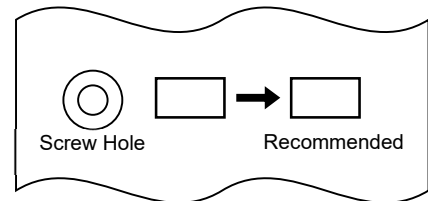

### 11.7 Cleaning Conditions

Products shall be cleaned on the following conditions.

- (1) Cleaning temperature shall be limited to 40°C max.
- (2) Ultrasonic cleaning shall comply with the following conditions with avoiding the resonance phenomenon at the mounted products and P.C.B..

Power : 20 W / l max.      Frequency : 28kHz to 40kHz      Time : 5 minutes max.

- (3) Cleaner

1. Alternative cleaner
  - Isopropyl alcohol (IPA)
2. Aqueous agent

Aqueous agent should not be used because it may cause quality deterioration.

- (4) Other cleaning

Please contact us.

### 11.8 Resin coating

The inductance value may change due to high cure-stress of resin to be used for coating/molding products. An open circuit issue may occur by mechanical stress caused by the resin, amount/cured shape of resin, or operating condition etc. Some resin contains some impurities or chloride possible to generate chlorine by hydrolysis under some operating condition may cause corrosion of wire of coil, leading to open circuit. So, please pay your careful attention when you select resin in case of coating/molding the products with the resin. Prior to use the coating resin, please make sure no reliability issue is observed by evaluating products mounted on your board.

### 11.9 Caution for use

Sharp material such as a pair of tweezers or other material such as bristles of cleaning brush, shall not be touched to the winding portion to prevent the breaking of wire.



**11.10 Handling of a substrate**

After mounting products on a substrate, do not apply any stress to the product caused by bending or twisting to the substrate when cropping the substrate, inserting and removing a connector from the substrate or tightening screw to the substrate.

Excessive mechanical stress may cause cracking in the product.

Bending

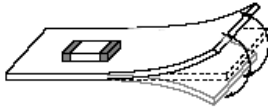

Twisting

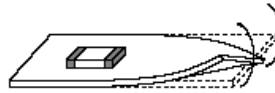
**11.11 Storage and Handling Requirements****(1) Storage period**

Use the products within 12 months after delivered.

Solderability should be checked if this period is exceeded.

**(2) Storage conditions**

• Products should be stored in the warehouse on the following conditions.

Temperature : -10 ~ 40°C

Humidity : 15 to 85% relative humidity No rapid change on temperature and humidity

• The electrode of the products is coated with solder. Don't keep products in corrosive gases such as sulfur, chlorine gas or acid, or it may cause oxidization of electrode, resulting in poor solderability.

• Products should not be stored on bulk packaging condition to prevent the chipping of the core and the breaking of winding wire caused by the collision between the products.

• Products should be stored on the pallet for the prevention of the influence from humidity, dust and so on.

• Products should be stored in the warehouse without heat shock, vibration, direct sunlight and so on.

**(3) Handling Condition**

Care should be taken when transporting or handling product to avoid excessive vibration or mechanical shock.

**12. ⚠ Note**

(1) Please make sure that your product has been evaluated in view of your specifications with our product being mounted to your product.

(2) You are requested not to use our product deviating from the reference specifications.

(3) The contents of this reference specification are subject to change without advance notice. Please approve our product specifications or transact the approval sheet for product specifications before ordering.