

ROHS-Y

# **SPECIFICATION**

## **For Reference**

Date : 5/June/2023

Product Description : Polymer Aluminum Electrolytic Capacitor

Customer Part Number :

Murata Part Number : ECAS Series

Murata Manufacturing Co.,Ltd.

Chemical Device Department

Sales Promotion Section

\_\_\_\_\_ (Company name/Dept.)

All specifications may be changed without notice.

Please check with our sales representatives or product engineers before ordering.

1. Scope

These specifications are applied to Polymer Aluminum Electrolytic Capacitor for electronic equipment use.

Please contact us beforehand when you use it besides this use.

2. Part Number Description

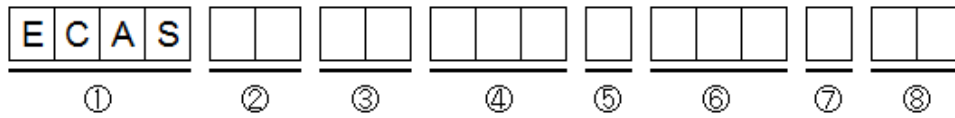

- ① Series : ECAS
- ② Dimensions : See 3.1
- ③ Rated Voltage : See 3.2
- ④ Capacitance : See 3.3
- ⑤ Capacitance Tolerance : See 3.4
- ⑥ ESR : See 3.5
- ⑦ Packing : See 3.6
- ⑧ Individual Specification Code : Murata management Code

3. Descriptions

3.1 Dimensions

(mm)

Case Code	L	W	T	W1	S
D3	7.3±0.3	4.3±0.2	1.4±0.1	2.4±0.2	1.3±0.2
D4	7.3±0.3	4.3±0.2	1.9±0.1	2.4±0.2	1.3±0.2
D6	7.3±0.3	4.3±0.2	2.8±0.3	2.4±0.2	1.3±0.2

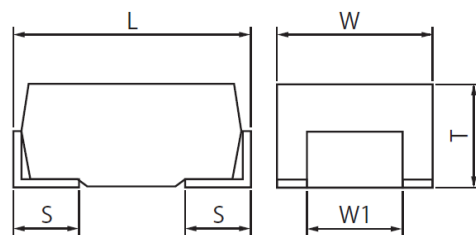

3.2 Rated Voltage

Code	Voltage
0D	2V
0E	2.5V
0J	6.3V
1A	10V
1C	16V
1D	20V
1E	25V

### 3.3 Capacitance

This code is shown by three-digit numeric. The unit is pico-farad (pF). The first and the second figures show the significant digits of the nominal capacitance, and the third figure shows the number of "0" following the significant digit.

Ex.)

Code	Capacitance
476	47 $\mu$ F
107	100 $\mu$ F
227	220 $\mu$ F
477	470 $\mu$ F

### 3.4 Capacitance Tolerance

Code	Tolerance
M	$\pm$ 20%

### 3.5 ESR

This code is shown by three-digit alphanumeric. The unit is milli-ohm (m $\Omega$ ). If there is a decimal point, it is expressed by the capital letter "R".

Ex.)

Code	ESR
4R5	4.5m $\Omega$
009	9m $\Omega$
010	10m $\Omega$

### 3.6 Packing

Code	Specification
K	$\Phi$ 330mmplastic taping packing

### 3.7 Individual Specification Code

Expressed by two figures.

## 4. Part Number and Minimum Packaging Quantity

## 4.1 Part Numbers and Standards

Murata Part Number	Rated Voltage (V.DC)	Cap. ( $\mu$ F)	Cap Tol. (%)	Case Size	ESR (m $\Omega$ ) 100kHz/ +25 $^{\circ}$ C	Leakage Current ( $\mu$ A)	Ripple Current (Arms) 100kHz	Reflow Peak Temp. ( $^{\circ}$ C) <sup>(1)</sup>
ECASD40D227M009K00	2	220	$\pm$ 20	D4	9	44.0	3.0	245
ECASD40E337M006KA0	2.5	330	$\pm$ 20	D4	6	82.5	3.0	260
ECASD40E477M006KA0	2.5	470	$\pm$ 20	D4	6	117.5	3.5	260
ECASD60E477M4R5K00	2.5	470	$\pm$ 20	D6	4.5	117.5	4.0	245
ECASD60E477M006K00	2.5	470	$\pm$ 20	D6	6	117.5	3.5	245
ECASD40J107M015K00	6.3	100	$\pm$ 20	D4	15	63.0	2.0	245
ECASD40J157M015K00	6.3	150	$\pm$ 20	D4	15	94.5	2.0	245
ECASD40J227M010KA0	6.3	220	$\pm$ 20	D4	10	138.6	3.0	260
ECASD60J337M009KA0	6.3	330	$\pm$ 20	D6	9	207.9	3.5	260
ECASD31A686M040KA0	10	68	$\pm$ 20	D3	40	204.0	1.6	260
ECASD41A107M040KA0	10	100	$\pm$ 20	D4	40	300.0	1.6	260
ECASD61A157M010KA0	10	150	$\pm$ 20	D6	10	150.0	3.0	260
ECASD31C476M040KA0	16	47	$\pm$ 20	D3	40	225.6	1.6	260
ECASD41C686M040KA0	16	68	$\pm$ 20	D4	40	326.4	1.6	260
ECASD61C107M012KA0	16	100	$\pm$ 20	D6	12	480.0	2.5	260
ECASD31D476M040KA0	20	47	$\pm$ 20	D3	40	282.0	1.6	260
ECASD41D476M040KA0	20	47	$\pm$ 20	D4	40	282.0	1.6	260
ECASD31E156M040KA0	25	15	$\pm$ 20	D3	40	112.5	1.6	260
ECASD31E226M040KA0	25	22	$\pm$ 20	D3	40	165.0	1.6	260
ECASD41E336M040KA0	25	33	$\pm$ 20	D4	40	247.5	1.6	260

Note: (1) Please refer to <7>Reflow Soldering, <Figure 1.> for our recommended reflow profile. (P.12)

4.2 Minimum Packaging Quantity

Case Size	Minimum Packaging Quantity(pcs)
D3	3,000
D4	3,000
D6	2,500

5. Markings

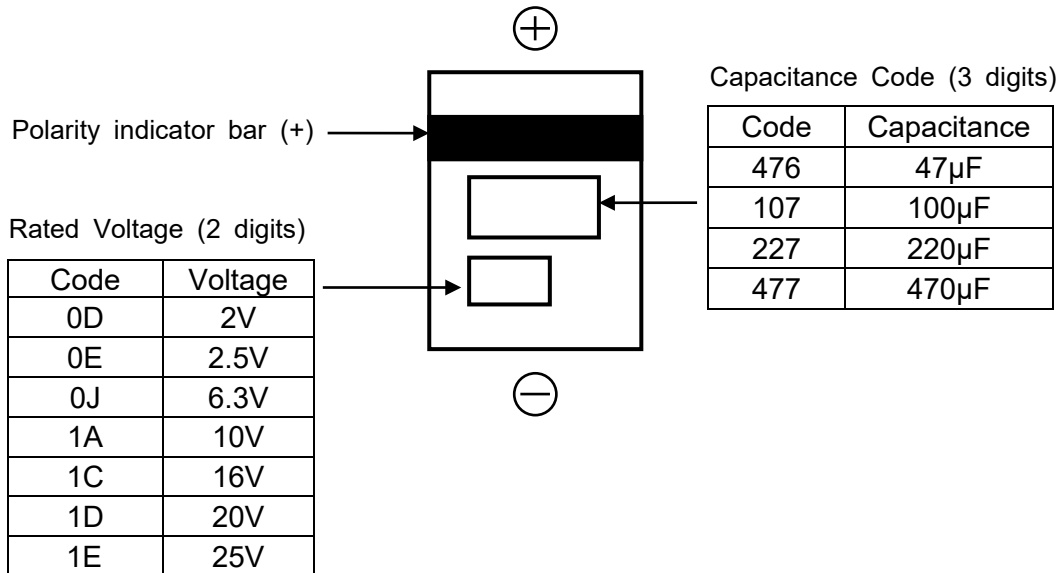

6. Characteristics

No	Item	Characteristics	Test Conditions
1	Operating temperature range	-40°C ~ +105°C	-
2	Leakage Current	≤ The value of No.4.1	Series resistor: 1000 ohm Applied voltage: Rated Voltage Measuring after 2 minutes of application Please conduct pre-conditioning below, if you have a doubt. Pre-conditioning: • Temperature: 105°C. • Applied voltage :Rated Voltage • Series resistor:1000 ohm • Charge time:1 hour. Then discharge and keep in the room temperature for 4h to 24h.
3	Capacitance tolerance	(See No.4.1)	Measuring frequency: 120Hz ±10% Measuring circuit: Equivalent series circuit Measuring voltage: +1Vr.m.s. Measuring temperature: 25 °C
4	Dissipation Factor	≤ 0.06	
5	ESR	≤ The value of No.4.1	Measuring frequency: 100kHz ±10% Measuring voltage: no more than +1Vr.m.s. Measuring temperature: 25 °C
6	Allowable Ripple Current	(See No.4.1)	Measuring frequency: 100kHz ±10% Part temperature: +20 to +105 °C
7	Solderability	More than 75% of each terminal face is covered by new solder	Lead Free Solder: Sn/3.0Ag/0.5Cu Flux: Rosin 25%, IPA 75% Solder temperature: 245 ±3°C Immersing time: 3 ±0.3s

No.	Item	Characteristics		Test Conditions
8	Moisture resistance under no bias	Leakage Current	$\leq$ 300% of initial specified value $\leq$ 750% of initial specified value (ECASD40E337M006KA0, ECASD40E477M006KA0)	Test temperature: 60 $\pm$ 2 $^{\circ}$ C Relative humidity: 90~95%RH Test time: 500+24, -0h
		Capacitance Change	-20% and +50% of initial measured value	
		Dissipation Factor	$\leq$ 0.12	
		Appearance	No defects or abnormalities	
9	Moisture resistance under load	Leakage Current	$\leq$ The value of No.4.1	Test temperature: 60 $\pm$ 2 $^{\circ}$ C Relative humidity: 90~95%RH Test time: 500+24, -0h Applied voltage: Rated Voltage
		Capacitance Change	-20% and +50% of initial measured value	
		Dissipation Factor	$\leq$ 0.12	
		Appearance	No defects or abnormalities	
10	Shelf life	Leakage Current	$\leq$ The value of No.4.1	Test temperature: 105 $\pm$ 2 $^{\circ}$ C Test time: 1000+48, -0h
		Capacitance Change	$\pm$ 10% of initial measured value	
		Dissipation Factor	$\leq$ 0.06	
		Appearance	No defects or abnormalities	
11	Endurance	Leakage Current	$\leq$ The value of No.4.1	Test temperature: 105 $\pm$ 2 $^{\circ}$ C Test time: 2000+48, -0h Applied voltage: Rated Voltage
		Capacitance Change	$\pm$ 20% of initial measured value	
		Dissipation Factor	$\leq$ 0.06	
		Appearance	No defects or abnormalities	
12	Surge	Leakage Current	$\leq$ The value of No.4.1	Temperature: +85 $^{\circ}$ C for W.V. 2V~10V Room temp. for W.V. 12.5V~25V Applied voltage: Rated voltage x1.25 Current Limiting resistance: 33ohm (in series) for W.V. 2V~10V 1kohm (in series) for W.V. 12.5V~25V Discharge resistance: 33ohm (in series) for W.V. 2V~10V 1kohm (in series) for W.V. 12.5V~25V Charge on/off: 30 sec. each, 1000 times
		Capacitance Change	$\pm$ 10% of initial measured value	
		Dissipation Factor	$\leq$ 0.06	
		Appearance	No defects or abnormalities	

The measurement condition in No.2 to 4 applies to No.8 to 12.

7. Packaging

7.1 Carrier Tape Configuration and Dimension

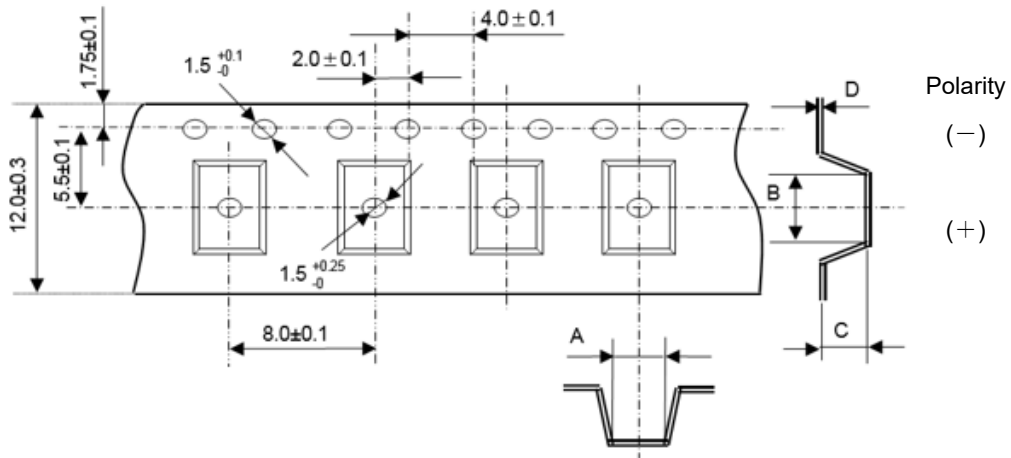

Type	Cavity Size (mm)				Minimum Qty. (pcs.)
	A*	B*	C*	D*	
D3, D4	4.60	7.65	2.16	0.23	3,000
D6	4.60	7.65	3.20	0.27	2,500

\* Nominal values

7.2 Tape Packaging

Capacitors will be inserted in embossed carrier tape that will be sealed with cover tape as described below. No more than half of a sprocket hole will be covered by cover tape.

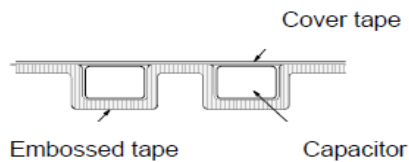

7.3 Taping Leader

Tape has a leader and a trailer as described below.

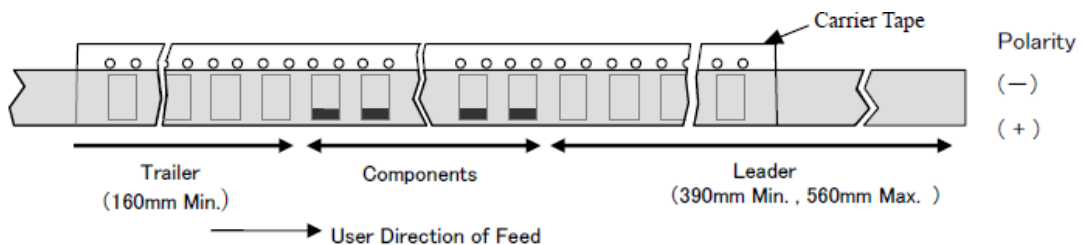

7.4 Cover Tape Peel Strength

Cover tape peel strength required to be within the range of 0.1-0.8N when tested as below .

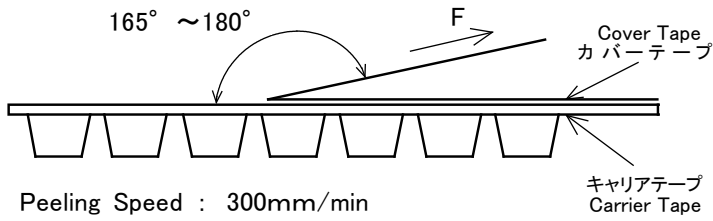

7.5 Empty Cavities of Carrier Tape Section

Empty cavities of filled section must be lower than 0.1% or 1pc of the total of reel quantity and sequential empty cavities are not allowed. Devices placed in one reel must satisfy the specified reel quantity.

7.6 Reel Configuration and Dimension

Tape with capacitors is wound in a reel as described below.

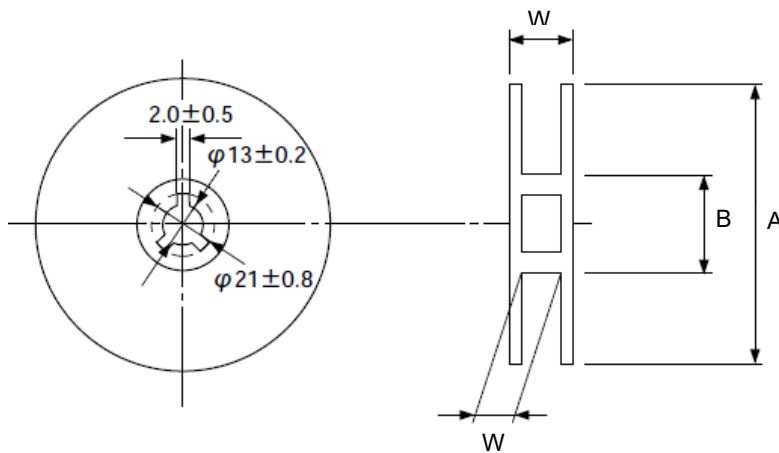

Reel Size	Tape Width	A	B	W	W1
Φ330	12	330.0 ±2.0	100.0 ±1.0	17.4 ±1.5	13.4 ±1.5

(mm)

7.7 Labels on Reel

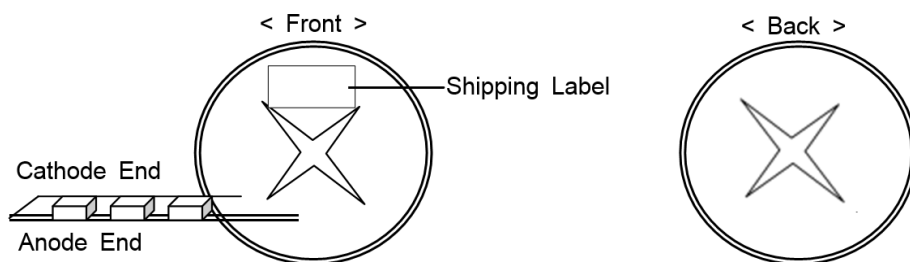

Shipping Label that show the customer parts number, our parts number, our company name, inspection number and quantity, will be put in outside of reel.

Please note the position of sipping label when feeding a tape.



### 7.8 Moisture Proof Aluminum Laminated Bag Packaging

A reel of the products is packaged in a moisture proof aluminum laminated bag and labels are put on the bag as shown below. One desiccant and a humidity indicator are put on the backside of the reel before slightly drawing the vacuum and sealing the bag.

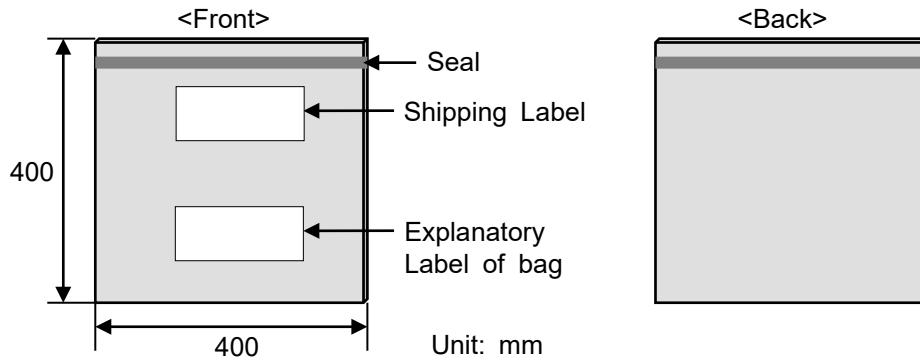

Note) The size of the Moisture Proof Aluminum Laminated Bag is a rough value.

### 7.9 Cardboard Box Packaging

Moisture proof aluminum laminated bags of products are packaged in a cardboard box.

### 8. Quality Assurance

<1> Murata's responsibility for the quality of this product shall be limited to those specified in this document.

<2> It is a customer's responsibility to judge fitness of this product for assembly process, end use and operating environment.

## 9. Caution for Use



## Caution

## 9.1 Limitation of the use

Please contact us before using our products for the applications listed below which require especially high reliability for the prevention of defects which might directly cause damage to the third party's life, body or property.

- ① Aircraft equipment
- ② Aerospace equipment
- ③ Undersea equipment
- ④ Power plant control equipment
- ⑤ Medical equipment
- ⑥ Transportation equipment (vehicles, trains, ships, etc.)
- ⑦ Traffic signal equipment
- ⑧ Disaster prevention/crime prevention equipment
- ⑨ Data-processing equipment
- ⑩ Application of similar complexity and/or reliability requirements to the applications listed in the above.



## Caution

## 9.2 Storage Condition

<1> Term of warranty for this product is two years after packaging in a moisture-proof bag, under the conditions below with sealed packaging.

Recommended storage environment    Room temperature: 5-30 degree

Humidity: no more than 60%RH

<2> Polymer aluminum electrolytic capacitors should not be stored in an atmosphere consisting of corrosive gas(e.g. hydrogen sulfide, sulfur dioxide, chlorine, ammonia gas, etc.).

<3> Polymer aluminum electrolytic capacitors should be stored in a dry atmosphere, avoiding direct sunlight and condensation. If capacitors are kept at a higher humidity, the following problems may occur:

- ① Leakage current will increase at the beginning of use and damage the circuit.
- ② Moisture absorbed in a resin will evaporate and expand with heat of mounting and damage the mold resin.

<4> Please confirm a dry state with a humidity indicator card after open immediately. If 20% indication was in a pink state after opened, it is recommended to bake under the conditions below.

<5> The capacitors should be kept dry using desiccators or any other methods after unsealing the moisture-proof packaging. If more than one week has passed under the recommended storage environment specified above after unsealing the packaging, it is recommended to bake under the conditions below.

Recommended baking conditions    Temperature: 60(+0, -5) degree C

Time: 168 hours

<6> This product meets MSL-3.

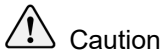

Caution

### 9.3 Cautions for Use

#### <1> Prohibited Circuits for use

Do not use the capacitor with the following circuit.

- ① Time-constant circuit
- ② Coupling circuits
- ③ 2 or more capacitors connected serially
- ④ Circuit which are greatly affected by leakage current

#### <2> Polarity

Polymer aluminum electrolytic capacitor is polarized. Please not to reverse the polarity when using. If reverse voltage is applied even momentary, it may damage the oxide film and the capacitor itself. Please verify the orientation of the capacitor before use in accordance with the drawing of "Markings" in Item 5.

#### <3> Operating Voltage

When DC-rated capacitors are to be used in AC or ripple current circuits, be sure to maintain the  $V_{o-p}$  value of the applied voltage or the  $V_{o-p}$  which contains DC bias within the rated voltage range. When the voltage is applied to the circuit, starting or stopping may generate irregular voltage for a transit period because of resonance or switching. Be sure to use a capacitor with a rated voltage range that includes these irregular voltages.

#### <4> Inrush Current

Extreme inrush current may cause short circuit or leakage current increase. If the inrush current exceeds 20A, adding protection circuit is recommended.

#### <5> Allowable Ripple Current

Please not to apply ripple current exceeding the allowable value specified in the standards in Item 4.1. If excessive current is applied, it may generate heat and the heat may damage the capacitor. The sum of DC voltage and the peak AC voltage shall not exceed the rated voltage. The sum of the DC voltage and the peak AC voltage shall not allow a voltage reversal.

#### <6> Operating Temperature

The operating temperature limit depends on the capacitor.

- ① Do not apply temperature exceeding the upper operating temperature. It is necessary to select a capacitor with a suitable rated temperature that will cover the operating temperature range. Also it is necessary to consider the temperature distribution in equipment and the seasonal temperature variable factor.
- ② Consider the self-heating of the capacitor. The surface temperature of the capacitor shall be the upper operating temperature or less when including the self-heating factors.

<7>Reflow Soldering

- ① Please not to apply excessive force to the capacitor during insertion as well as after soldering. The excessive force may result in damage to electrode terminals and/or degradation of electrical performance.
- ② Resistance testing to reflow soldering was conducted in accordance with the reflow profile described in Figure 1. If this profile is adopted, reflow soldering can be repeated no more than two times.

< Figure 1. > Our Recommended Reflow Profile

**Peak temp.: 260°C max.**

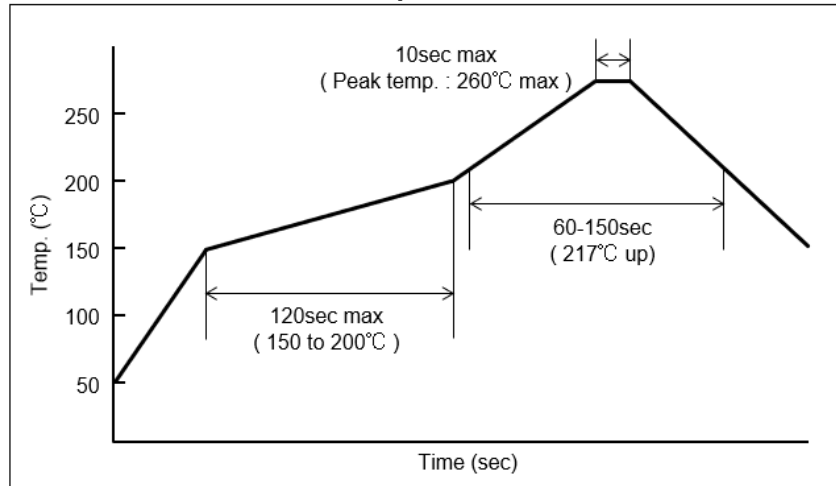

**Peak temp.: 245°C max.**

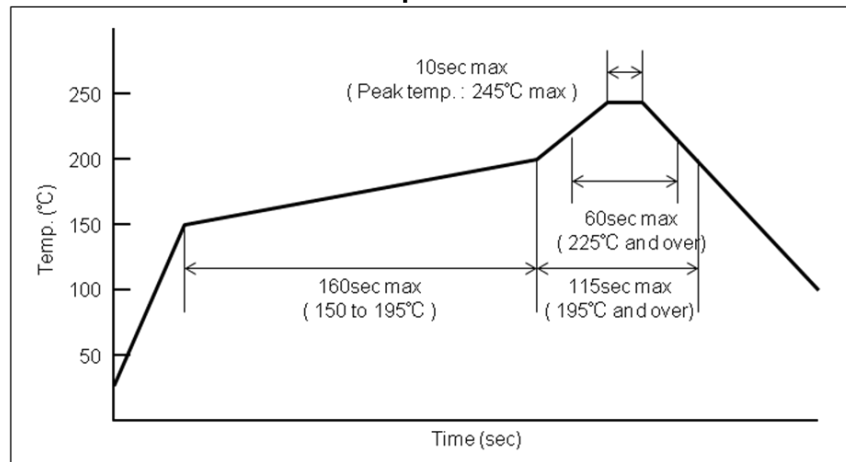

- ③ Please refer to figure below for designing land pattern.

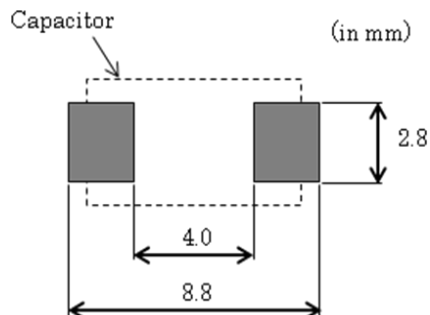

## &lt; 8 &gt; Operating environment

Confirm the environment in which the equipment will operate is under the specified conditions. Do not use the equipment under the following environments.

- ① Being splattered with water or oil.
- ② Being exposed to direct sunlight.
- ③ Being exposed to Ozone, ultraviolet rays or radiation.
- ④ Being exposed to toxic gas (e.g. hydrogen sulfide, sulfur dioxide, chlorine, ammoniagas, etc.)
- ⑤ Being exposed to excessive vibrations or mechanical shocks.
- ⑥ Being exposed to condensable environments.

## &lt; 9 &gt; Disposal

Polymer aluminum electrolytic capacitors should be disposed of as industrial waste in accordance with laws.

## 9.4 Manufacturing factory

Murata Electronics (Thailand), Ltd.



## 10. Proposal

- ① When you use, please evaluate in a state mounted by your product.
- ② Please do not use this product other than the mention contents of this specification.
- ③ We think that it is not appropriate to mention a contract matter about the business in specifications, a drawing, other technical documentations.

Therefore, we invalidate it when there is a mention about the range of the responsibility of us such as a guarantee of quality, PL, industrial property, the export control in these technical documentations that your company was made.

Pease offer these matters separately in the basic contract document etc.