

Chip Inductor (Chip Coil) Power Inductor (Wire Wound Type)

LQH3NP_G0 Series (1212 Size)

■ Dimensions

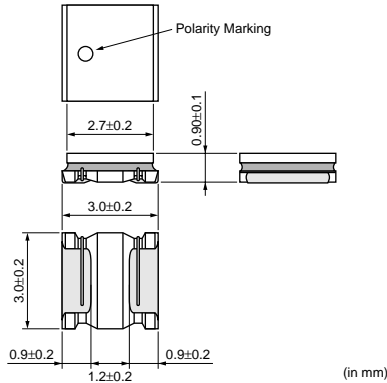

■ Packaging

Code	Packaging	Minimum Quantity
L	180mm Embossed Tape	1500
K	330mm Embossed Tape	6000

■ Rated Value (□: packaging code)

Part Number	Inductance	Rated Current (Based on Inductance Change)	Rated Current (Based on Temperature Rise)	DC Resistance	Self Resonance Frequency (min.)
LQH3NPN1R0NG0□	1.0μH±30%	1650mA	1525mA	0.08ohm±20%	160MHz
LQH3NPN1R5NG0□	1.5μH±30%	1300mA	1470mA	0.10ohm±20%	130MHz
LQH3NPN2R2NG0□	2.2μH±30%	1250mA	1270mA	0.14ohm±20%	100MHz
LQH3NPN3R3NG0□	3.3μH±30%	850mA	1130mA	0.18ohm±20%	75MHz
LQH3NPN4R7NG0□	4.7μH±30%	800mA	925mA	0.26ohm±20%	60MHz
LQH3NPN6R8NG0□	6.8μH±30%	650mA	710mA	0.45ohm±20%	48MHz
LQH3NPN100MG0□	10μH±20%	500mA	630mA	0.57ohm±20%	45MHz
LQH3NPN100NG0□	10μH±30%	500mA	630mA	0.57ohm±20%	45MHz
LQH3NPN150NG0□	15μH±30%	370mA	475mA	0.91ohm±20%	35MHz
LQH3NPN220MG0□	22μH±20%	340mA	430mA	1.1ohm±20%	25MHz
LQH3NPN220NG0□	22μH±30%	340mA	430mA	1.1ohm±20%	25MHz
LQH3NPN330MG0□	33μH±20%	250mA	345mA	2.1ohm±20%	24MHz
LQH3NPN330NG0□	33μH±30%	250mA	345mA	2.1ohm±20%	24MHz
LQH3NPN470MG0□	47μH±20%	170mA	270mA	3.0ohm±20%	19MHz
LQH3NPN470NG0□	47μH±30%	170mA	270mA	3.0ohm±20%	19MHz
LQH3NPN680MG0□	68μH±20%	150mA	235mA	4.2ohm±20%	16MHz
LQH3NPN680NG0□	68μH±30%	150mA	235mA	4.2ohm±20%	16MHz
LQH3NPN101MG0□	100μH±20%	140mA	165mA	8.0ohm±20%	10MHz
LQH3NPN101NG0□	100μH±30%	140mA	165mA	8.0ohm±20%	10MHz
LQH3NPN151MG0□	150μH±20%	110mA	145mA	11.0ohm±20%	10MHz
LQH3NPN151NG0□	150μH±30%	110mA	145mA	11.0ohm±20%	10MHz
LQH3NPN221MG0□	220μH±20%	100mA	130mA	14.0ohm±20%	8.5MHz
LQH3NPN221NG0□	220μH±30%	100mA	130mA	14.0ohm±20%	8.5MHz
LQH3NPN251MG0□	250μH±20%	80mA	130mA	15.0ohm±20%	8.0MHz

Test Frequency: 1MHz Class of Magnetic Shield: Magnetic shield of magnetic powder in resin Operating Temperature Range: -40 to +85°C
Only for reflow soldering.

Continued on the following page.

● This data sheet is applied for CHIP INDUCTORS (CHIP COILS) used for General Electronics equipment for your design.

⚠ Note:

1. This datasheet is downloaded from the website of Murata Manufacturing co., Ltd. Therefore, it's specifications are subject to change or our products in it may be discontinued without advance notice. Please check with our sales representatives or product engineers before ordering.
2. This datasheet has only typical specifications because there is no space for detailed specifications. Therefore, please approve our product specifications or transact the approval sheet for product specifications before ordering.

 Continued from the preceding page.

Part Number	Inductance	Rated Current (Based on Inductance Change)	Rated Current (Based on Temperature Rise)	DC Resistance	Self Resonance Frequency (min.)
LQH3NPN251NG0□	250 μ H \pm 30%	80mA	130mA	15.0ohm \pm 20%	8.0MHz

Test Frequency: 1MHz Class of Magnetic Shield: Magnetic shield of magnetic powder in resin Operating Temperature Range: -40 to +85°C
Only for reflow soldering.

■ Notice (Rated Current)

<Rated Current>

(Based on Inductance Change)

When Rated Current is applied to the Products,
Inductance will be within \pm 30% of nominal
Inductance value.

<Rated Current>

(Based on Temperature Rise)

When Rated Current is applied to the Products,
self-generation of heat will rise to 40°C or less.

■ Inductance-Frequency Characteristics (Typ.)

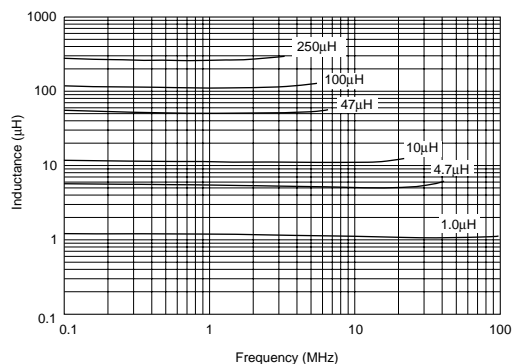

■ Inductance-Current Characteristics (Typ.)

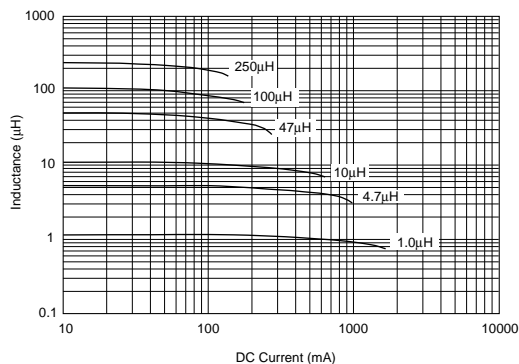

■ Temperature Rise Characteristics (Typ.)

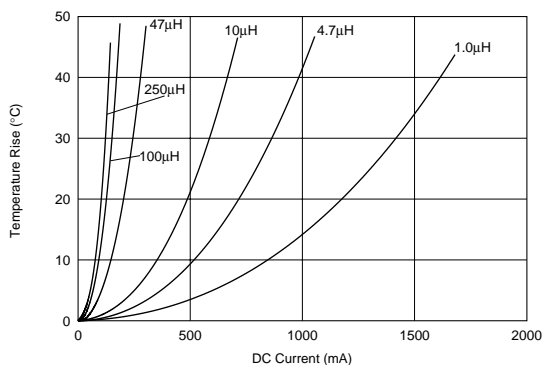

Continued on the following page. 

● This data sheet is applied for CHIP INDUCTORS (CHIP COILS) used for General Electronics equipment for your design.

⚠ Note:

1. This datasheet is downloaded from the website of Murata Manufacturing co., Ltd. Therefore, it's specifications are subject to change or our products in it may be discontinued without advance notice. Please check with our sales representatives or product engineers before ordering.
2. This datasheet has only typical specifications because there is no space for detailed specifications. Therefore, please approve our product specifications or transact the approval sheet for product specifications before ordering.

 Continued from the preceding page.

■ Caution/Notice

Caution (Rating)

Do not use products beyond the rated current as this may create excessive heat.

Notice

Solderability of Tin plating termination chip might be deteriorated when low temperature soldering profile where peak solder temperature is below the Tin melting point is used. Please confirm the solderability of Tin plating termination chip before use.

● This data sheet is applied for CHIP INDUCTORS (CHIP COILS) used for General Electronics equipment for your design.

Note:

1. This datasheet is downloaded from the website of Murata Manufacturing co., Ltd. Therefore, it's specifications are subject to change or our products in it may be discontinued without advance notice. Please check with our sales representatives or product engineers before ordering.
2. This datasheet has only typical specifications because there is no space for detailed specifications. Therefore, please approve our product specifications or transact the approval sheet for product specifications before ordering.